

PREPARED BY: _____	DATE _____	<h1>SHARP</h1> <p>ELECTRONIC COMPONENTS GROUP SHARP CORPORATION</p> <h2>SPECIFICATION</h2>	SPEC No. MC89201
APPROVED BY: _____	DATE _____		FILE No. _____
			ISSUE Feb. 8, 1989
			PAGE 29 Pages
			APPLICABLE DIVISION
			<input type="checkbox"/> ELECTRONIC COMPONENTS DIV. <input type="checkbox"/> SEMICONDUCTOR APPLICATION DIV. <input checked="" type="checkbox"/> LIQUID CRYSTAL DISPLAY DIV. <input type="checkbox"/> PHOTO VOLTAGE DIV.

DEVICE SPECIFICATION FOR  
 Dot Matrix LCD Unit  
 (240 X 64 dot, Gray type STN,  
 Transflective, Positive type  
 with LCD controller and CG-ROM)

MODEL No.  
 LM24014H

CUSTOMER'S APPROVAL

DATE \_\_\_\_\_

BY \_\_\_\_\_

PRESENTED  
 BY H. Nakajima

H. Nakajima  
 Department General Manager  
 Engineering Department 2  
 ELECOM Group  
 SHARP CORPORATION

**SHARP**

## 1. Application

This data sheet is to introduce the specification of the Dot-Matrix LCD Unit LM24014H .

(240 × 64 dot, Gray type STN, Transflective, Positive type, with LCD controller and CG-ROM)

(Transflector : NITTO transflector PI type (R=66.4Z(typ), T=30.4Z(typ)) )

## 2. Construction and Outline

Construction : 240 × 64 full dot graphic display unit

Outline : See Fig. 6 .

Connection : See Fig. 6 . and Table. 5 .

Option : This unit is a transflective type.

And an optional EL backlight can be installed.

Applicable EL is LFOB08 (Standard model, white long-life type) and LFOB09 (Standard model blue-green long-life type)

There shall be no scratches, stains, chips, distortions and other external drawbacks that may affect the display function.

Rejection criteria shall be noted in Inspection Standard S-U-008.

**SHARP**

3. Mechanical Specifications

Table 1

Parameter	Specifications	Unit
Outline dimensions *1	180(W) × 65(H) × 10.5MAX(D)	mm
Effective viewing area	132.6(W) × 39(H)	mm
Display format	240(W) × 64(H) full dot	-
Dot size	0.48(W) × 0.48(H)	mm
Dot spacing	0.05	mm
Dot color *2	Dark blue	-
Background color *2	Light gray (backlight off)	-
Weight	approx. 120	g

\*1 : Excluded Oscillator. (See Fig.6)

\*2 : Due to the characteristics of the LC Material, the colors vary with environmental temperature.

4. Absolute Maximum Ratings

4-1. Electrical Absolute Maximum Ratings

Table 2

Parameter	Symbol	Min.	Max.	Unit	Remark
Supply voltage (Logic)	VDD-VSS	0	6.0	V	Ta=25°C
Supply voltage (LCD drive)	VDD-VEE	0	18.0	V	Ta=25°C
Input voltage	VIN	0	VDD	V	Ta=25°C



4-2. Environmental Condition

Table 3

Item	Tstg		Topr		Remark
	MIN.	MAX.	MIN.	MAX.	
Ambient temperature	-25°C	+60°C	0°C	+45°C	Note 4
Humidity	Note 1		Note 1		No condensation
Vibration	Note 2		Note 2		3 directions (X/Y/Z)
Shock	Note 3		Note 3		6 directions (±X/±Y/±Z)

Note 1)  $T_a \leq 40^\circ\text{C}$  ..... 95% RH Max  
 $T_a > 40^\circ\text{C}$  ..... Absolute humidity shall be less than  
 $T_a = 40^\circ\text{C} / 95\% \text{ RH}$

Note 2) Frequency : 10 ~ 55Hz  
 Vibration width : 1.5mm  
 Interval : 10Hz ~ 55Hz ~ 10Hz  
 (1 min)  
 2 hours for each direction of X/Y/Z (6 hours as total)

Note 3) Acceleration : 100G  
 Pulse width : 6ms  
 3 times for each direction of ±X/±Y/±Z.

Note 4) Care should be taken so that the LCD Unit may not be exposed the temperature ranges out of this specifications.



5. Electrical specifications

5-1. Electrical characteristics

Table 4

Ta=25c°, V<sub>DD</sub>=5V±5%

Parameter	Symbol	Conditions	MIN.	TYP.	MAX.	Unit
Supply voltage (Logic)	V <sub>DD</sub> -V <sub>SS</sub>		4.75	5.0	5.25	V
Supply voltage (LCD drive)	V <sub>EE</sub> -V <sub>SS</sub>	V <sub>DD</sub> =5V (Note)	-12.0	-	-6.0	V
Input signal voltage	V <sub>IN</sub>	"H" Level	V <sub>DD</sub> -2.2	-	V <sub>DD</sub>	V
		"L" Level	0	-	0.8	V
Output signal voltage	V <sub>OUT</sub>	"H" Level	V <sub>DD</sub> -0.3	-	V <sub>DD</sub>	V
		"L" Level	0	-	+0.3	V
Supply Current (Logic)	I <sub>DD</sub>	V <sub>DD</sub> =5V V <sub>EE</sub> =-10V	-	12	15	mA
Supply current (LCD drive)	I <sub>EE</sub>		-	1.5	2.0	mA
Power consumption	P <sub>d</sub>		-	75	95	mW

Note) The viewing angle θ where obtains the maximum contrast can be set by adjusting above V<sub>EE</sub>-V<sub>SS</sub>. Refer to Fig.2 for the definition of θ.

The typical value of LCD supply voltage normally means the optimum rating when set the θ at 15°. This rating varies around ± 0.5V in each unit.

**SHARP**

## 5-2. Contrast Adjustment of LCD Display Element.

Use the externally adjustable resistor (VR) to adjust the LCD display contrast for the change in viewing angle or power supply voltage.

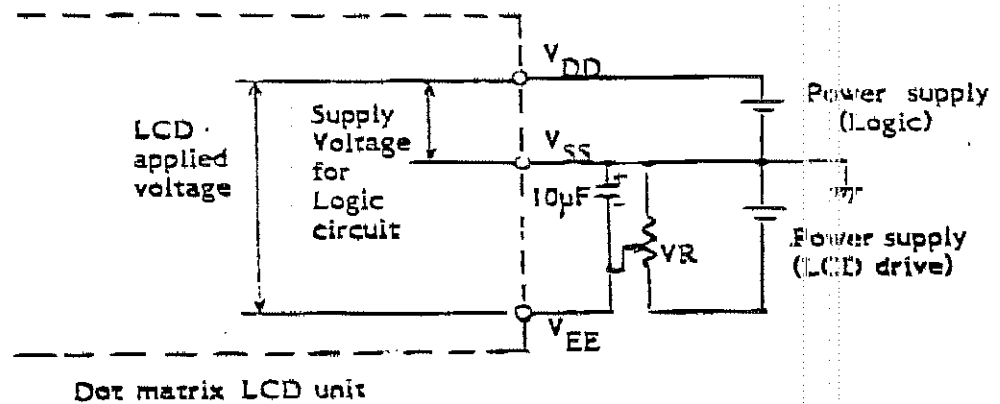

How to connect the adjustable resistor (example)

**SHARP**

## 5-3. Interface signals

Table.5

Pin No.	Symbols	Description	I/O
1	FGND	Frame Ground (Connected to Bezel)	-
2	VSS	Ground potential (Logic)	-
3	VDD	Power supply to logic and LCD (+)	-
4	VEE	Power supply to LCD (-)	-
5	WR	Data write	Input
6	RD	Data read	Input
7	CE	Chip Enable	Input
8	C/D	Code/Data	Input
9	NC	Non connection	-
10	RESET	Controller reset	Input
11	D0	Data bus (LSB)	I/O
12	D1	Data bus	I/O
13	D2		
14	D3		
15	D4		
16	D5		
17	D6		
18	D7	Data bus (MSB)	I/O
19	FS	Font Select	Note (2) - Input
20	NC	Non connection	-

Note (1) Pin No. and its location are shown in Fig.6.

Note (2) In case of FS="H" : 6×8 Character font  
 In case of FS="L" : 8×8 Character font

SHARP

## 5-4. Interface timing chart.

Fig.1 Interface Timing Chart

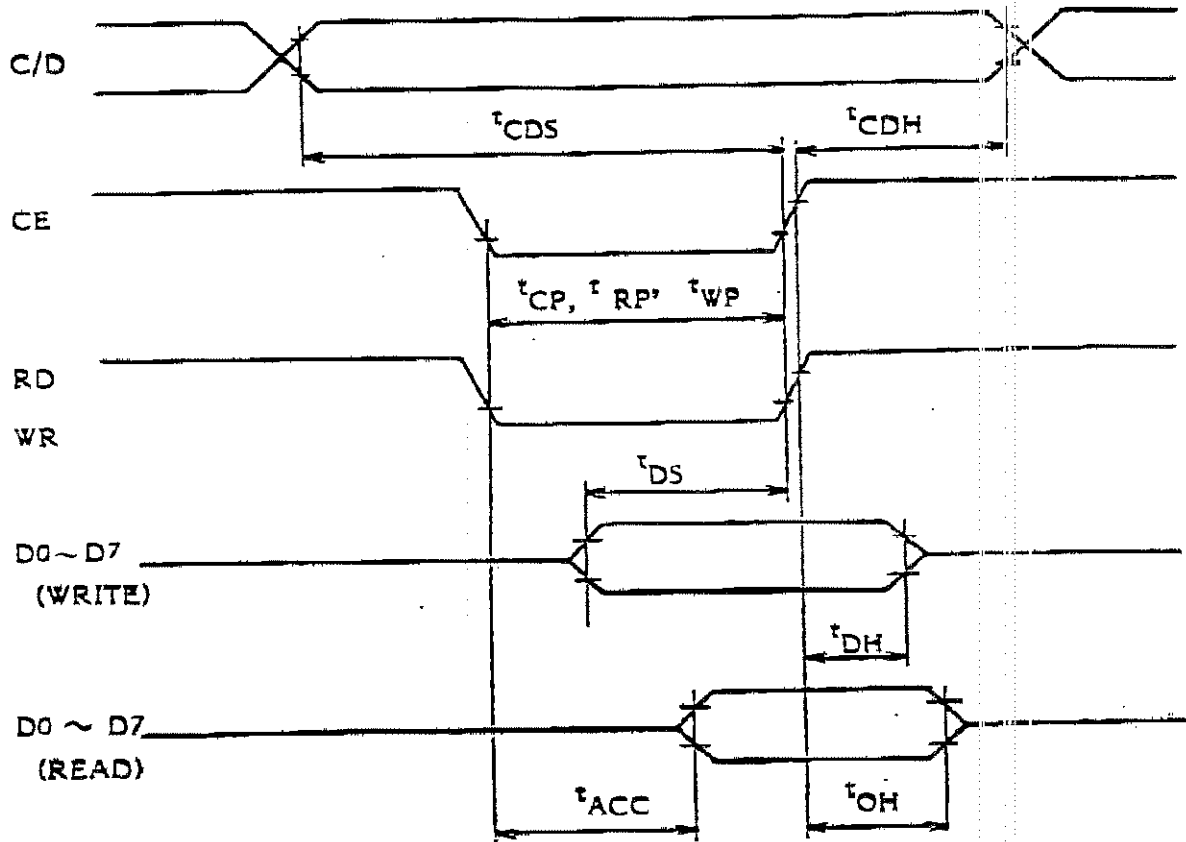

Table. 6 Interface timing ratings

Item	Symbol	Condition	MIN.	MAX.	Unit
C/D set up time	$t_{CDS}$		100	-	ns
C/D hold time	$t_{CDH}$		10	-	ns
CE, RD, WR clock width	$t_{CP}, t_{RP}, t_{WP}$		80	-	ns
Data set up time	$t_{DS}$		80	-	ns
Data hold time	$t_{DH}$		40	-	ns
Access time	$t_{ACC}$		-	150	ns
Data output hold time	$t_{OH}$		10	50	ns



5-5. Character Generator Pattern.

Table. 7

ROM Code 0101

ROM Code	0	1	2	3	4	5	6	7	8	9	A	B	C	D	E	F
0	0	1	2	3	4	5	6	7	8	9	A	B	C	D	E	F
1	0	1	2	3	4	5	6	7	8	9	A	B	C	D	E	F
2	0	1	2	3	4	5	6	7	8	9	A	B	C	D	E	F
3	0	1	2	3	4	5	6	7	8	9	A	B	C	D	E	F
4	0	1	2	3	4	5	6	7	8	9	A	B	C	D	E	F
5	0	1	2	3	4	5	6	7	8	9	A	B	C	D	E	F
6	0	1	2	3	4	5	6	7	8	9	A	B	C	D	E	F
7	0	1	2	3	4	5	6	7	8	9	A	B	C	D	E	F

**SHARP**

(5-6) Example of RAM address set (In case of FS="H")

(1) Example of relation between Text mode and RAM address

Text home position 0000H 40 Character  
 Text area 0028H 8 Lines

0000H	0001H	0026H	0027H
0028H	0029H	004EH	004FH
0050H	0051H	0076H	0077H
0118H	0119H	013EH	013FH

In Text mode, display pattern is memorized by 6x8 character font. The character in Table.9 is displayed for Data code.

(2) Example of relation between Graphic mode and RAM address

Graphic home position 1000H 240 X 64 Data  
 Graphic area 0028H

1000H	1001H	1026H	1027H
1028H	1029H	104EH	104FH
1050H	1051H	1076H	1077H
19DBH	19DCH	19FEH	19FFH

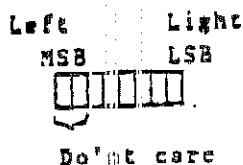

In Graphic mode, display pattern shall be memorized by pattern of 6x1 dot. The screen of this unit is divided to 40 byte (horizontal) x 64 byte (vertical). 1 byte data is translated binary code. "1" is "ON", and "0" is "OFF". Upper 2 bit cannot be displayed.

- Note(1) Display memory size is 8 Kbyte. RAM address is from 0000H to 1FFFH.
- Note(2) In Text mode, display format is 40 character 8 lines, and character font is 6x8 dot in case of FS="H".
- Note(3) It is possible to classify freely to ranges of Text/Graphic in internal display RAM.
- Note(4) In case of setting Text/Graphic area bigger than real screen, it is possible to transfer the position of display window by transferring of home position. (Window function)
- Note(5) It is possible to overlay Text screen and Graphic screen.

**SHARP**

6. Instruction  
(6-1) Instruction table

Table.8

Function	Code											
	C/D	RD	WR	D7	D6	D5	D4	D3	D2	D1	D0	
Write memory (WTRM)	1	1	0	0	1	0	0	0	0	N1		
Write register (WTRG)	1	1	0	0	0	1	0	0	AR	OR	CP	
Display mode set (DSPM)	1	1	0	1	0	0	1	GD	TD	CD	CB	
Cursor pattern select (CSRP)	1	1	0	1	0	1	0	0	N2			
Data read/write (DR/W)	1	1	0	1	1	0	0	0	N3			
Auto mode (AS/R)	1	1	0	1	0	1	1	0	N4			
Mode set (MDST)	1	1	0	1	0	0	0	CG	N5			
Screen peaking (PEEK)	1	1	0	1	1	1	0	0	0	0	0	
Screen copy (COPY)	1	1	0	1	1	1	0	1	0	0	0	
Bit set/reset (BS/R)	1	1	0	1	1	1	1	S/R	BIT			
Status read	1	0	1	STATUS DATA								
Data (write)	0	1	0	WRITE DATA								
Data (read)	0	0	1	READ DATA								

\*\*\*\*\* Function \*\*\*\*\*

- (1) AND/OR/EX-OR functions of screen data between Text and Graphic. (MDST)
- (2) Read and Copy the data of display screen. (DR/W, PEEK, COPY)
- (3) Software programmable of Text/Graphic ranges in display memory. (WTRM)
- (4) Cursor ON/OFF/Brink. (DSPM)
- (5) Cursor pattern selectable. (CSRP)
- (6) Character ON/OFF/Inverse/Brink. (MDST)
- (7) Bit set and bit reset of display memory. (BS/R)
- (8) Programmable CG-RAM. (WTRG, MDST)

**SHARP**

## 6-2. Explanation of command.

## 7. Internal RAM Write (WTRM)

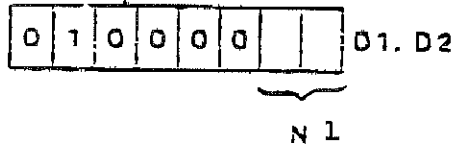

N1		D1	D2
00	Text Home Address	A low	A high
01	Number of Text Area	column	0
10	Graph. Home Address	A low	A high
11	Number of Graph. Area	column	0

1) The Text (or Graphic) home Address shows an address of the RAM which stored data displayed at the left end and the most upper position.

D1: Address lower byte.

D2: Address upper byte.

2) Column number of Text (or Graphic) Area.

D1: columns (" FFH "max)

D2: " 00H "



2. Internal Register Write (WTRG)

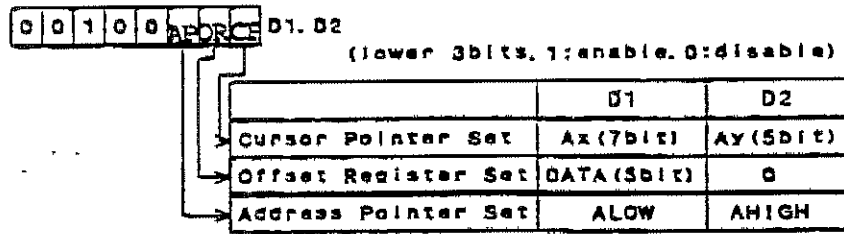

1) Cursor Pointer Set

The cursor is displayed at the position specified by cursor pointer.

D1: Point of horizontal (127 columns max. MSB don't care)

D2: Point of vertical (32 rows max. upper 3bits don't care)

2) Offset Register Set  
 Address of CG-RAM

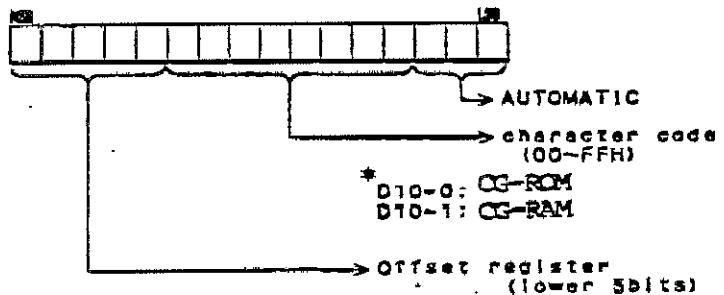

3) Address Pointer Set

Address pointer use to read or write display RAM.

**SHARP**

3. Display Mode Set (DSPM)



[lower 4 bits, 1:enable(ON)  
0:disable(OFF)]

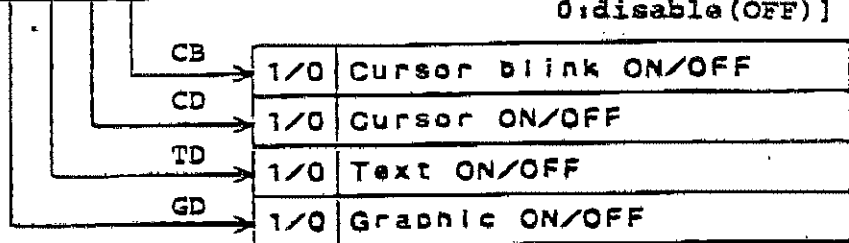

After hard reset, lower 4 bits is disabled.

4. Cursor Pattern Select (CSRP)

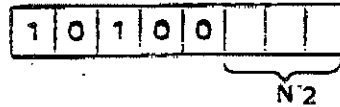

N2	
000	1 line cursor
001	2 "
010	3 "
011	4 "
100	5 "
101	6 "
110	7 "
111	8 "

1) Cursor Pattern Select

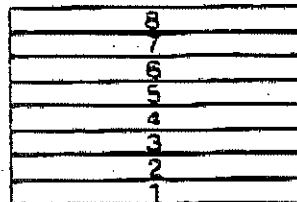



5. Data Read-Write (DR/W)

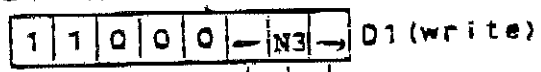

0	0	0	Data Write ADP increment
0	0	1	Data Read
0	1	0	Data Write address pointer decrement
0	1	1	Data Read
1	*	0	Data Write ADP nonvariable
1	*	1	Data Read

Write this command after address pointer set.  
Write this command after set data in case of "Data Write".

This instruction is 1byte data Read/Write command.

\*: don't care  
ADP: Address pointer

6. Auto Mode (AS/R)

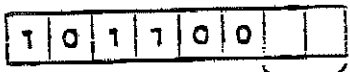

N4

N4		
0	0	Data Auto Write Set
0	1	Data Auto Read Set
1	*	Auto Reset

- \* This instruction is continuous data to Read (or Write) command.
- \* Auto mode operations should be performed after checking status STA2 or STA3.
- \* If "Data Auto Write(Read)" was set ,address pointer is increment by writing(reading) 1 byte data.
- \* If "Data Auto Write(Read)" was finished, set "Auto Reset".
- \* In case of "Auto Write", set "Auto Reset" after checking status STA3.

**SHARP**

## 7. Mode Set (MDST)

1 0 0 0 CG

N5

N5	
000	GF and TX are logically "ored"
001	GF and TX are logically "xored"
011	GF and TX are logically "anded"
100	TX attribute
0	CG-ROM (128 Character)
1	CG-RAM

Note: GF-Graphics  
 TX-Text  
 CG-Character Generator

\*This command is'nt cleared after hard reset.

3 2 1 0

				-Attribute RAM (use graphic area)
--	--	--	--	-----------------------------------

	0	0	0	Normal
0	1	0	1	Inverse
	0	1	1	Display disable
1				Blinking

Note: If CG-ROM mode was set, Character code "80-FFH" select automatically

- \*Only Text attribute.
- \*Use graphic area for attribute.
- \*If "Attribute" was used, Graphic is OFF.
- \*Method of programing.

- 1) Graphic "10010\*\*\*", write.
- 2) Write Attribute area.
- 3) Write home adress.
- 4) Mode set. "1000(1/0)\*\*", write.
- 5) Graphic ON. "10011\*\*\*", write.



**SHARP****B. Screen Peeking (PEEK)**

1	1	1	0	0	0	0	0
---	---	---	---	---	---	---	---

This instruction use to read displayed data.  
 It is possible to read logical combination data.  
 If the address wasn't graphic RAM area, this  
 instruction is ignored and status flag  
 (STA6) is set.

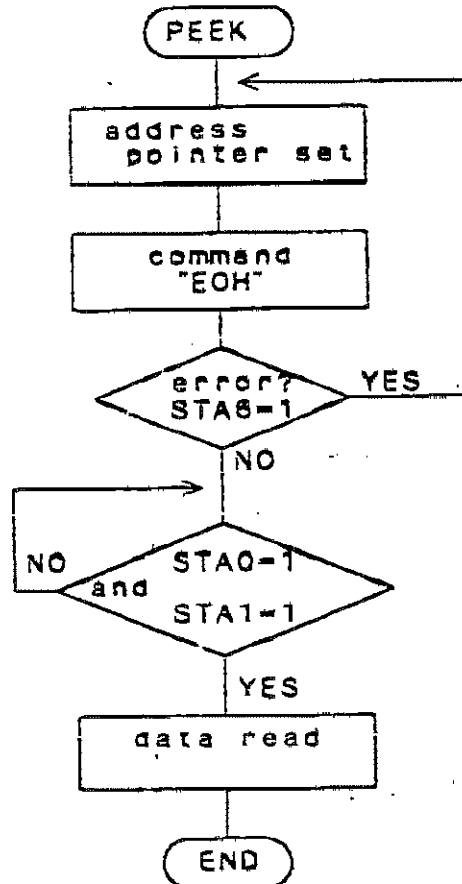

**SHARP****3. Screen Copy (COPY)**

1	1	1	0	1	0	0	0
---	---	---	---	---	---	---	---

If the address pointer accorded with graphic pointer, LCDC writes the displayed data of 1 line after according position in graphic RAM area. If the address wasn't graphic RAM area, this instruction is ignored and status flag (STA6) is set.

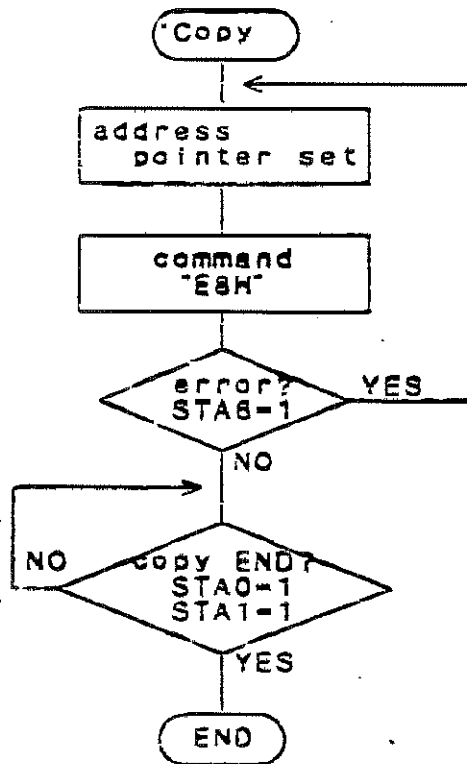

SHARP

## 10. Bit Set/Reset (BS/R)

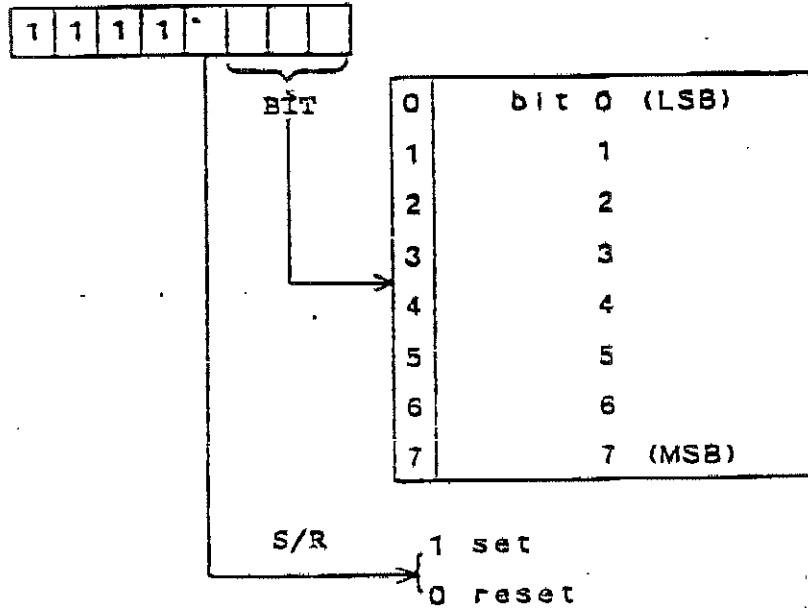

This instruction is command of bit manipulation.  
The individual bit is set(reset) by this command.

**SHARP**

## 6-3. Method of initial

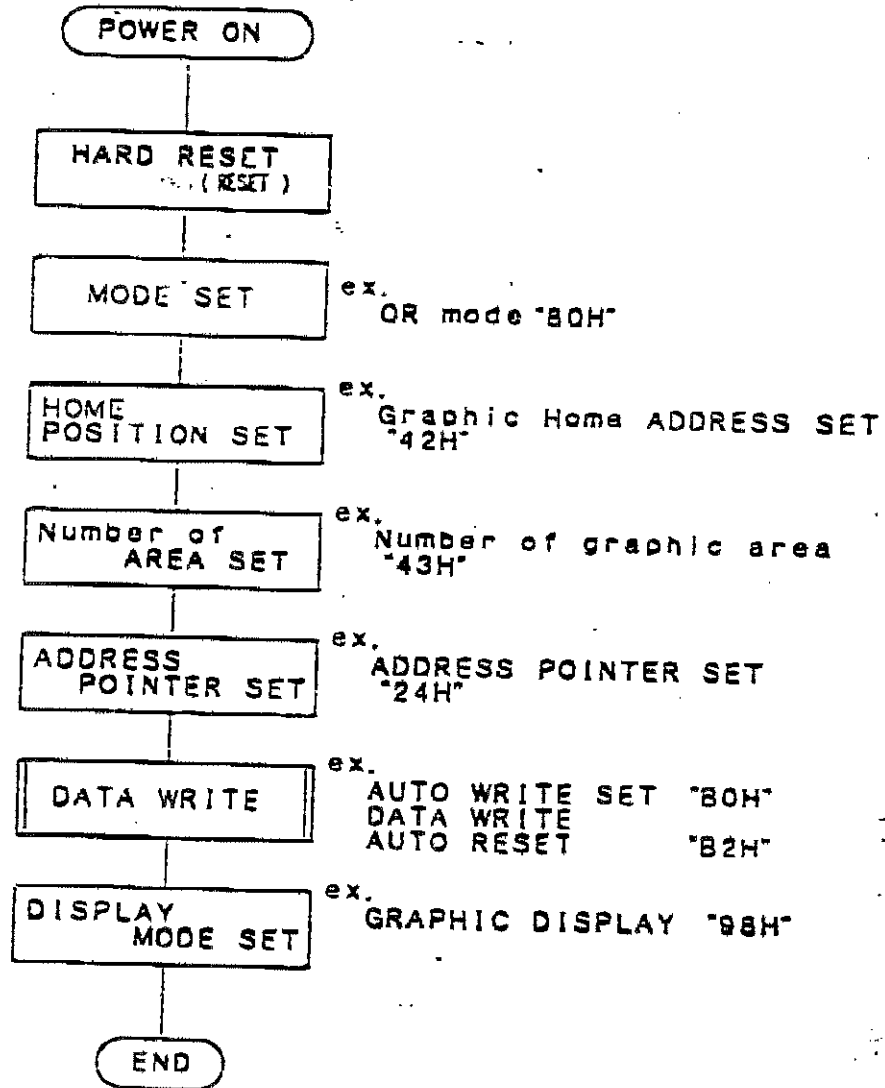

**SHARP**

6-4 Programing flow chart

STANDARD COMMUNICATION FLOW CHART WITH CPU

1. COMMAND WRITE

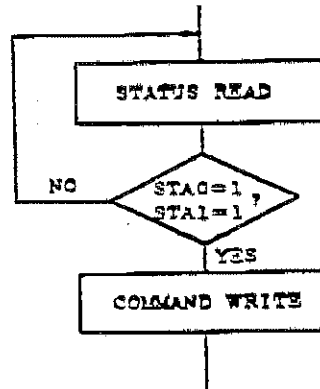

2. DATA WRITE

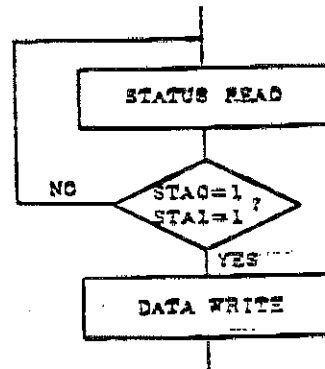

3. RELATION OF "COMMAND WRITE" , "DATA WRITE"

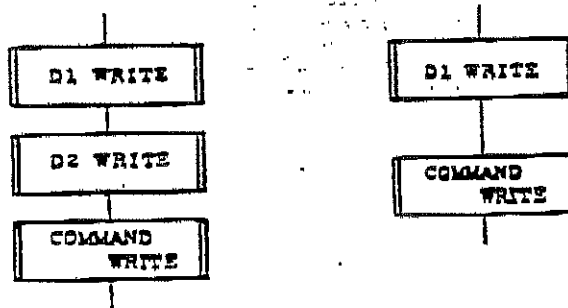

**SHARP**

6-5. Status data  
table. 9

STA0	Instruction	1: ready	0: busy
STA1	Data Read/Write	1: ready	0: busy
STA2	AUTO READ *1	1: ready	0: busy
STA3	AUTO WRITE *1	1: ready	0: busy
STA4	Don't care		
STA5	RESET *2	1: disable	0: enable
STA6	Error flag *3	1: error	0: right
STA7	Blink status	1: disp. ON	0: disp. OFF

MSB

LSB

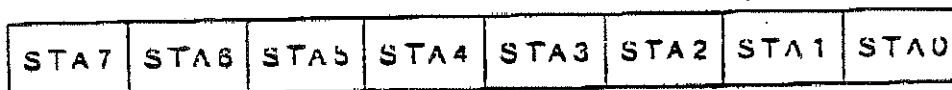

- \*1: Only under "Auto Mode".
- \*2: This unit cannot enable 1-2 ms since Power ON, because clock is unstable.
- \*3: If the address was set out of Graphic RAM area, this flag is set.  
 After writing next command, this flag is reset.  
 (See Page 16 or 17)

SHARP

7. Optical Characteristics (Backlight off, Reflective mode)  
 $V_{DD} = 5V$ 

Table -10

(Ta = 25°C)

Parameter	Symbol	Condition	Min.	Typ.	Max.	Unit	Remark	
Viewing angle range	$\theta_2 - \theta_1$	$\phi = 0^\circ$	$C_0 \geq 2.0$	60	-	-	dgr.	Note 1
	$\theta_1$		-	-	-30	dgr.	Note 1	
	$\theta_2$	$\theta_1 < \theta_2$	$C_0 = 2.0$	25	-	-	dgr.	Note 1
	$\theta_2 - \theta_1$	$\phi = 45^\circ$ $\phi = 315^\circ$	$C_0 \geq 2.0$	60	-	-	dgr.	Note 1
	$\theta_1$		$\theta_1 < \theta_2$	-	-	-30	dgr.	Note 1
	$\theta_2$		$C_0 = 2.0$	25	-	-	dgr.	Note 1
Contrast ratio	$C_0$	$\theta = 0^\circ$	5	7	-		Note 2	
Response speed	Rise	$T_r$	-	150	250	us	Note 3	
	Decay	$T_d$	-	300	450	us	Note 3	

Note 1) The viewing angle range may be defined as shown below.

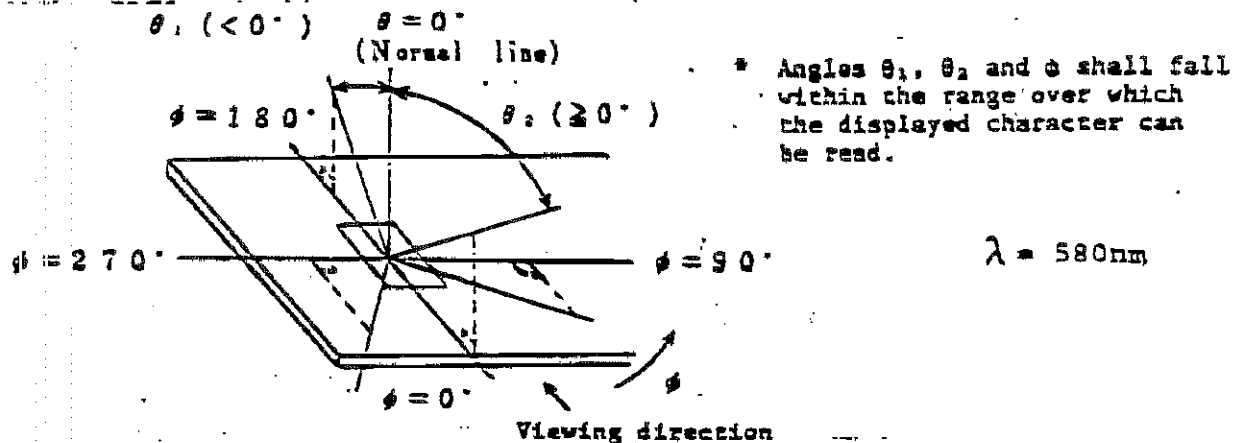

Fig. 2 Definition of Viewing Angle

Note 2) Contrast ratio may be defined as follows:

Contrast ratio is calculated by using the following formula when the waveform voltage (Fig. 4) is applied in the optical characteristics test method (Fig. 3).

$$\text{Contrast ratio} = \frac{\text{Photo-detector output voltage with non-select waveform being applied}}{\text{Photo-detector output voltage with select waveform being applied}}$$

SHARP

- Note 3) The response characteristics of photo-detector output are measured as shown in Fig. 4, assuming that input signals are applied so as to select and deselect the dots to be measured, in the optical characteristics test method shown in Fig. 3.
- Note 4) Table 10 shows the optical characteristics detected when the LCD applied voltage waveforms are in the highest frequency.\*
- \* The most critical condition for the characteristics of LCD.

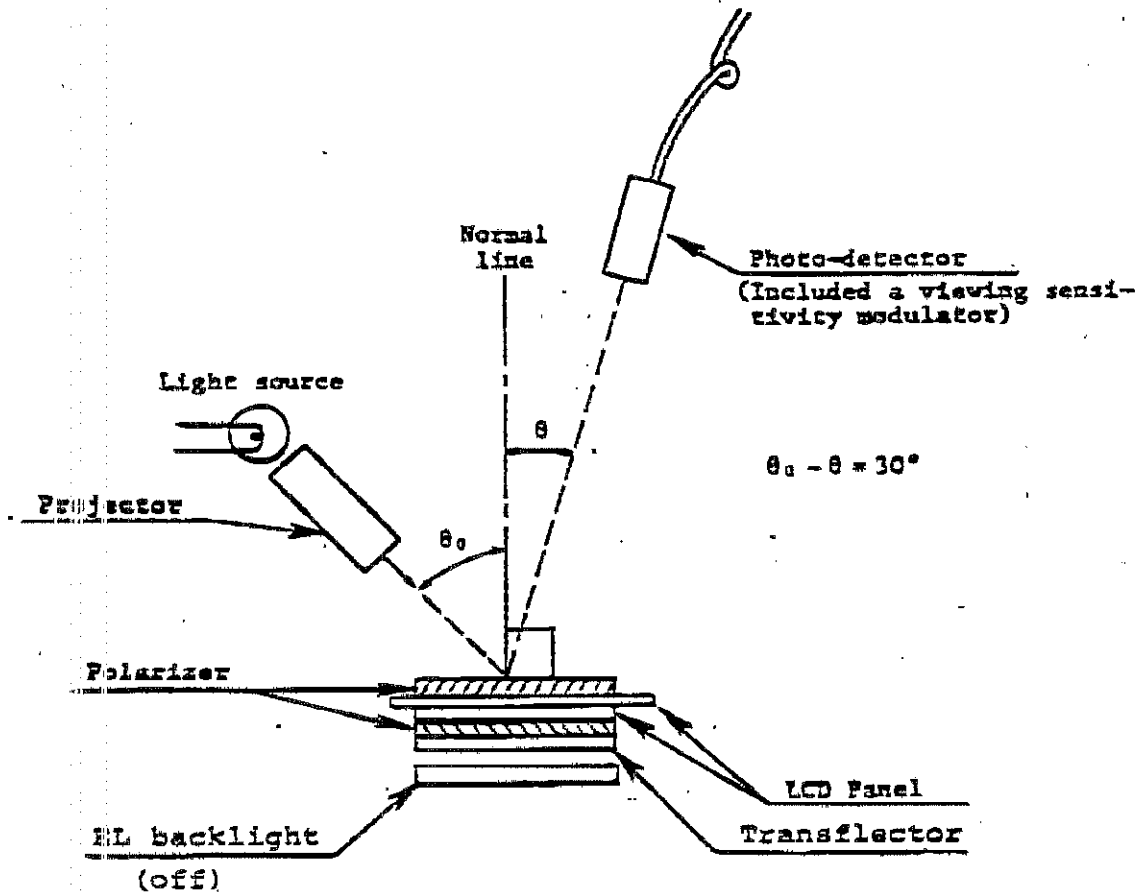

Fig. 3 Optical Characteristics Test Method



SHARP

[ Drive waveform ]

1/64 Duty

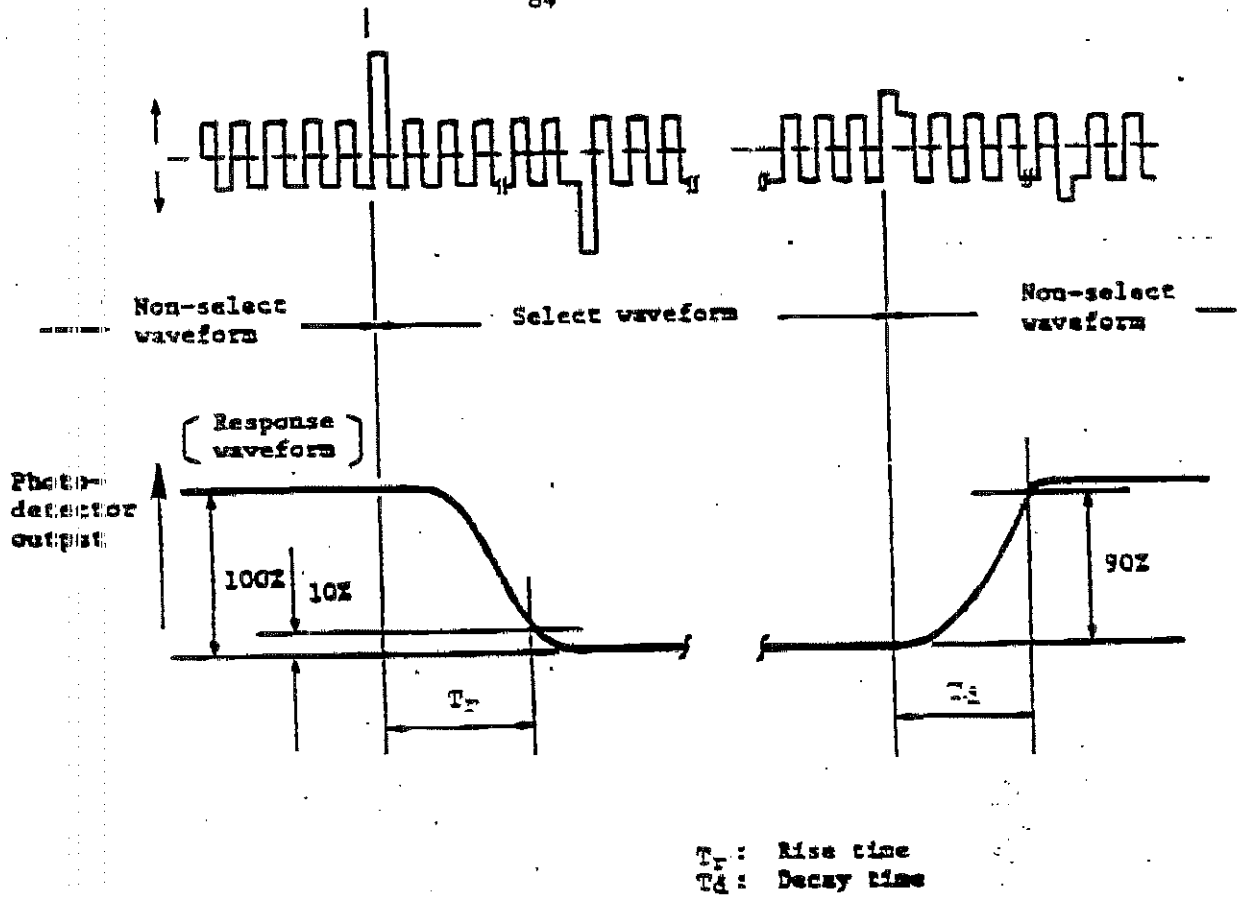
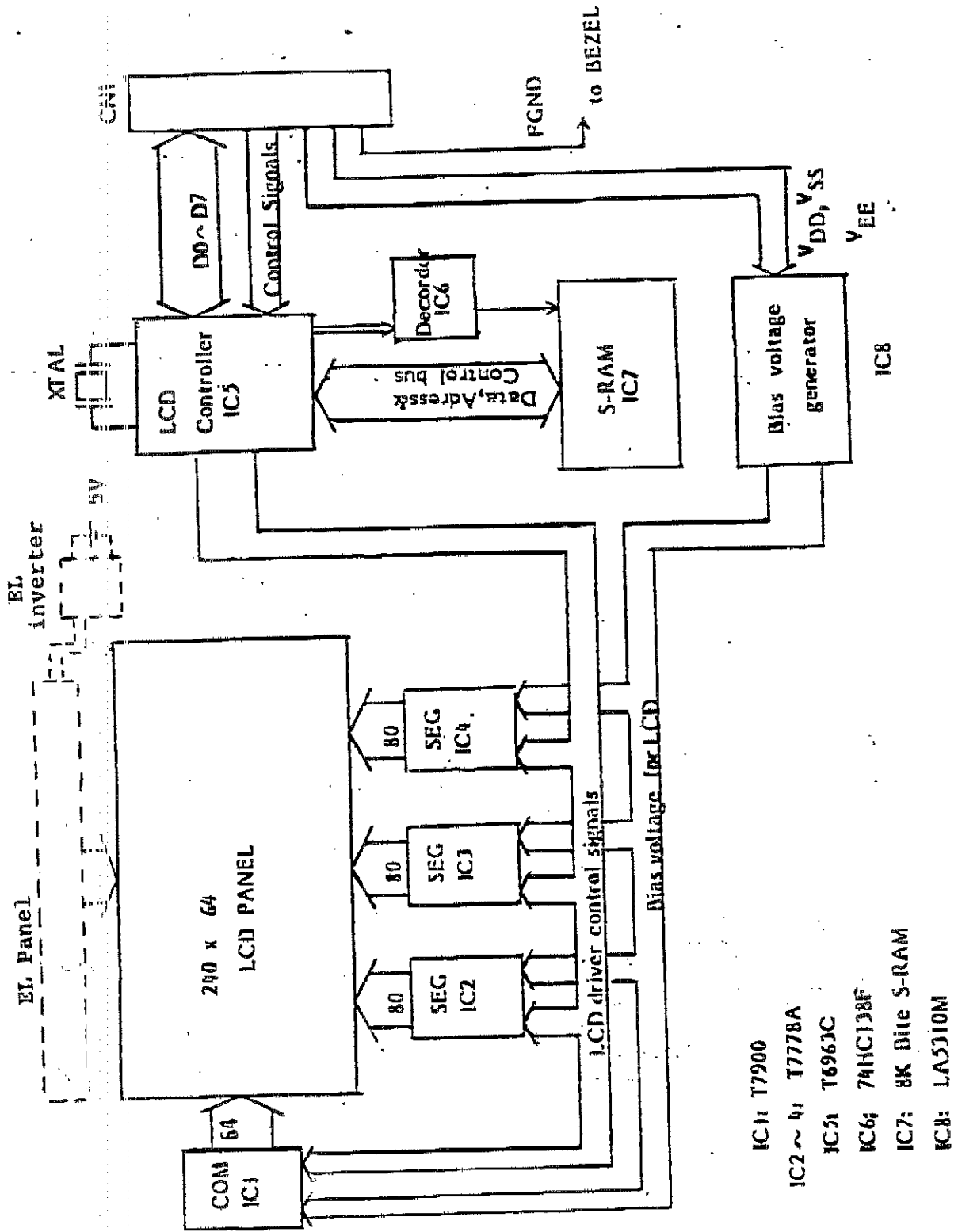

Fig. 4 Definition of Response Time

SHARP



- IC1: T7900
- IC2~4: T7778A
- IC5: T6963C
- IC6: 74HC138F
- IC7: 8K Bite S-RAM
- IC8: LA5310M

Fig.3 Circuit Block Diagram



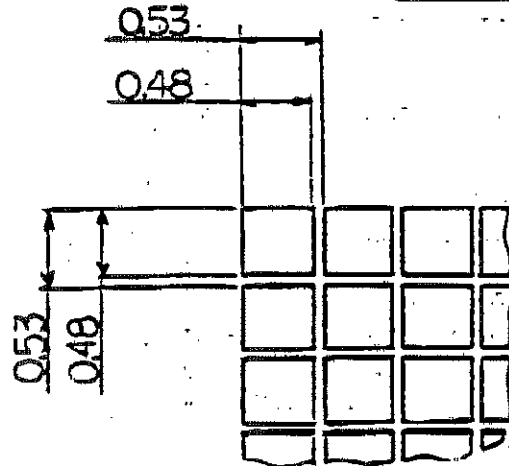
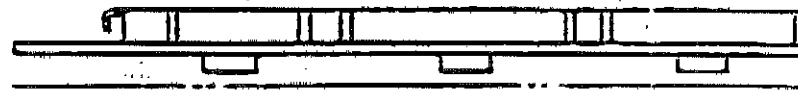
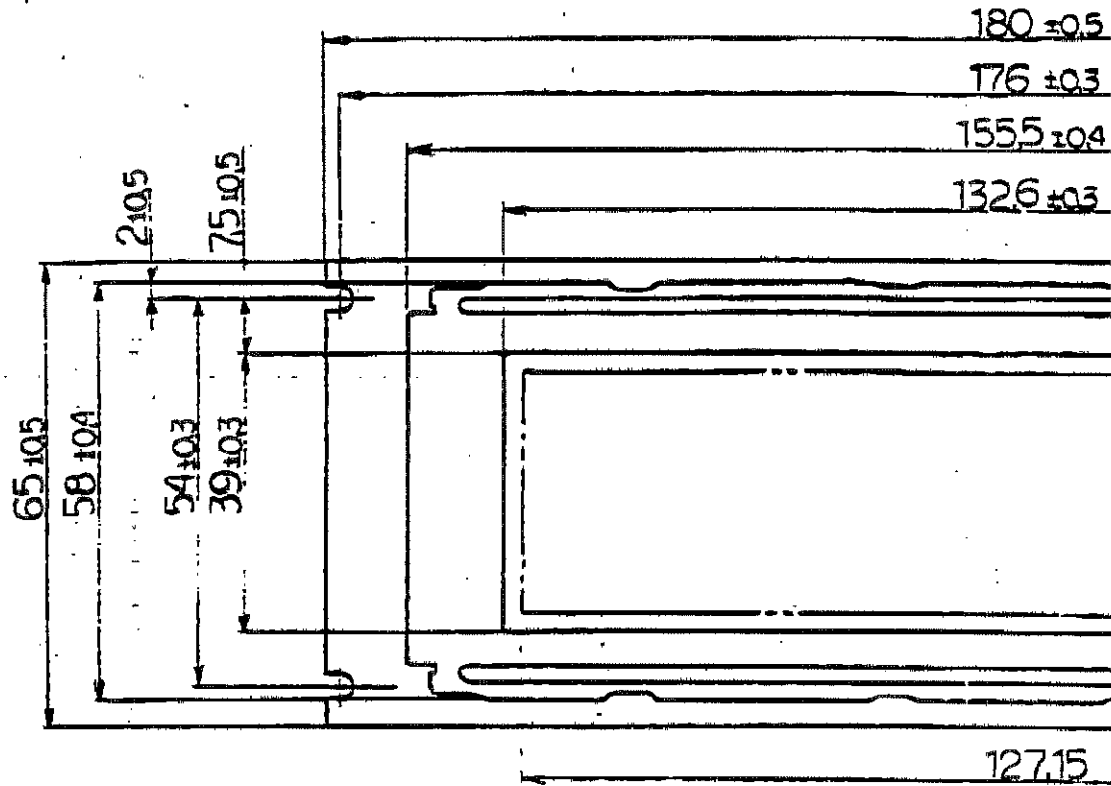

DOT SIZE (S. 20/1)

3) Height of mounted Oscillator.

2) Maximum thickness (except Oscillator)

Note 1) The bezel (metal frame) galvanized by white zinc

**SHARP****8. Precautions****8.1 Angle when installing the unit**

This unit's viewing angle is illustrated in Fig.7.

$$\theta_1 < \text{viewing range} < \theta_2 \quad (\theta_1 < 0^\circ, \theta_2 \geq 0^\circ)$$

(For the specific values of  $\theta_1$ ,  $\theta_2$ , refer to the Table(O.)

Please consider the optimum viewing conditions according to the purpose when installing the unit.

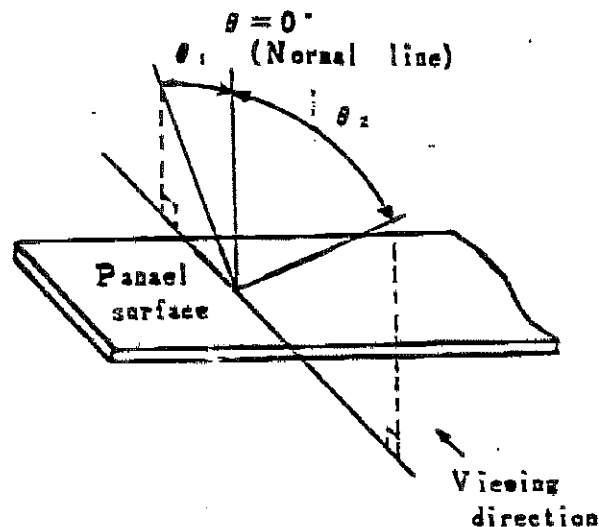

Fig. 7 Dot matrix LCD viewing angle

**8.2 Handling cautions**

This unit is installed using mounting tabs at the four corners of PCB or bezel.

When installing the unit, pay attention and handle carefully not to allow any undue stress such as twist or bend.

A transparent acrylic resin board or other type of protective panel should be attached to the front of the unit to protect the polarizer, LCD cells, etc.

**SHARP**

### 8.3 Notes on attachment

- (1) Since the front polarizer is easily damaged, please pay attention not to scratch on its face.
- (2) If the surface of the LCD cells needs to be cleaned, wipe its swiftly with cotton or other soft cloth. If still not completely clear, blow on it and wipe.
- (3) Water droplets, etc. must be wiped off immediately since they may cause color changes, staining, etc. if remained for a long time.
- (4) Since LCD is made of glass plates, dropping the unit or banging it against hard objects may cause cracking or fragmentation.
- (5) CMOS LSIs are equipped in this unit, so care must be taken to avoid the electro static charge, by earthing human body, etc. Take the following measures to protect the unit from the electric discharge via mounting tabs from the main system electrified with static electricity.
  - (1) Earth the metallic case of the main system (contact of the unit and main system).
  - (2) Insulate the unit and main system by attaching insulating washers made of bakelite or nylon, etc.

### 8.4 Power ON/OFF sequence

Please refer to fig.8 Power ON/OFF sequence.

### 8.5 Others

- (1) Avoid to expose the unit to the direct sun-light, strong ultra-violet light, etc. for a long time.
- (2) If stored at temperatures below specified storage temperature, the LC may freeze and be deteriorated. If storage temperature exceed the specified rating, the molecular orientation of the LC may change to that of a liquid, and they may not revert to their original state. As far as possible always store at normal room temperature.
- (3) If the LCD panel is removed from the LCD unit, it may cause the poor contact on reinsertion. So please avoid to dismantle the unit.

SHARP

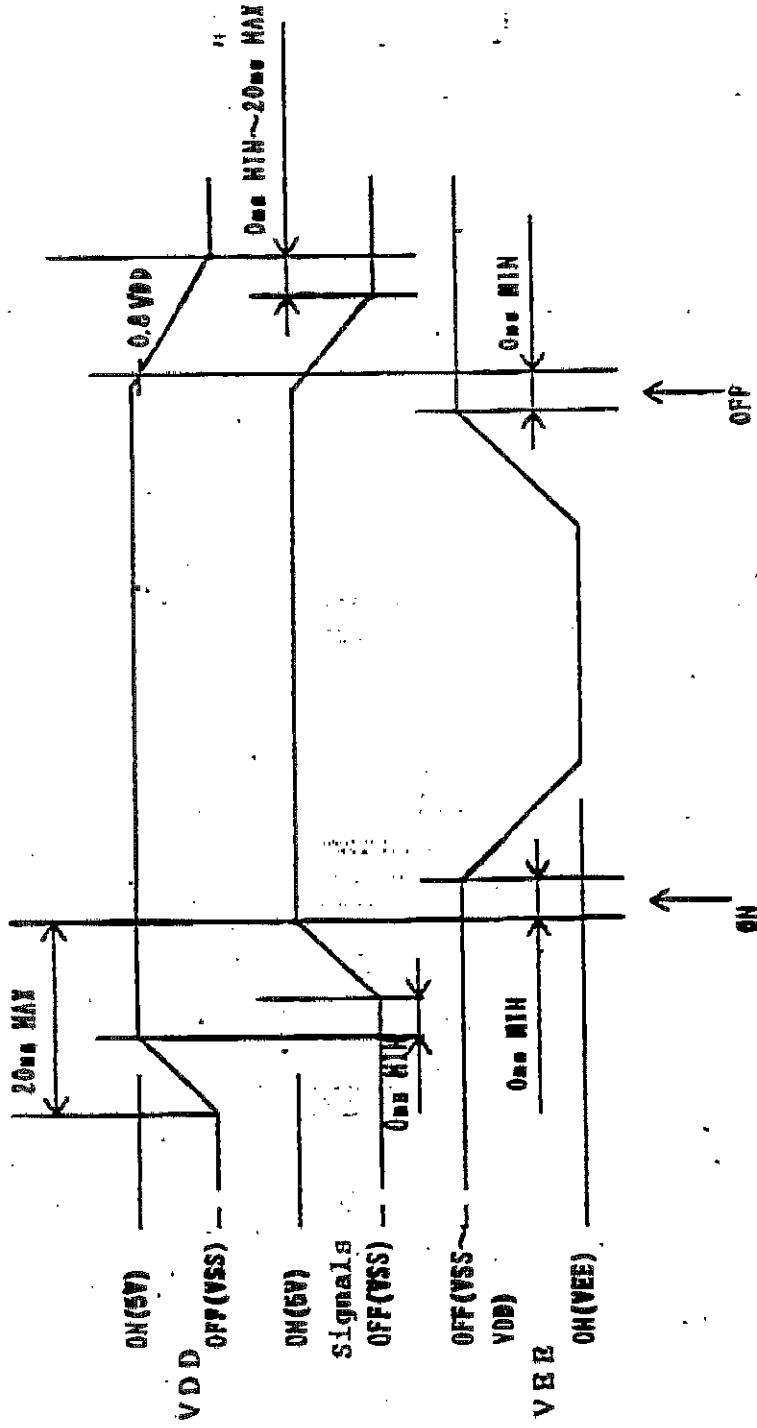

Fig. 8 Power ON/OFF sequence.

